

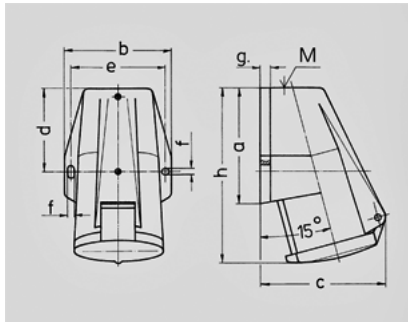

- 1268



	16 A
	4
	400 В
	6
	50-60
T	
	IP 44



Чертеж 1 MB 205	A Полоса	16			32		
		3	4	5	3	4	5
Размеры, мм.	a	91	91	91	102	102	102
	b	73	79	87	89	89	94
	c	86	93	99	108	108	114
	d	55	55	56,4	62	62	62
	e	62	68	76	77,5	77,5	84
	f	5,3	5,3	5,3	5,3	5,3	5,3
	g.	8	8	9	10	10	10
	h	132	132	132	153	153	153
	M	20	25	25	25	25	32
Макс. сечение кабеля до мм.		13	18	18	18	18	25
Клеммы для кабеля сечением от до мм²		1,5	1,5	1,5	2,5	2,5	2,5
		-4	-4	-4	-10	-10	-10